

**REPORT OF THE PUBLIC STAFF  
TO THE  
NORTH CAROLINA NATURAL DISASTER  
PREPAREDNESS TASK FORCE**

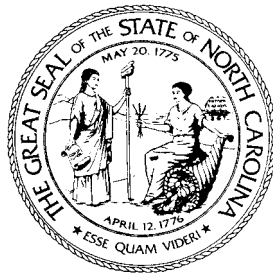

**THE FEASIBILITY OF PLACING  
ELECTRIC DISTRIBUTION FACILITIES  
UNDERGROUND**

**NOVEMBER 2003**



**NORTH CAROLINA  
PUBLIC STAFF  
UTILITIES COMMISSION**

November 21, 2003

Secretary Bryan E. Beatty, Chairman  
North Carolina Natural Disaster  
Preparedness Task Force  
4701 Mail Service Center  
Raleigh, North Carolina 27699-4701

Dear Secretary Beatty:

The Public Staff has completed its investigation and presents for your consideration its Report to the North Carolina Disaster Preparedness Task Force regarding the Feasibility of Placing Electric Distribution Facilities Underground. This investigation was conducted in conjunction with the earlier investigation of the December 2002 ice storm, which resulted in the report issued jointly by the Utilities Commission and the Public Staff on August 29, 2003. Both as Secretary of Crime Control and Public Safety, and as Chairman of the Governor's Task Force, your interest in this matter is significant. We are pleased to assist with the examination that you and others in the public arena require. This Report is also being filed by the Public Staff with the Utilities Commission.

In conducting its independent review of the December 2002 ice storm, the Commission held six public meetings in the most heavily affected areas of the state to allow public comment regarding the utility outages related to the storm. Questions were raised at the public meetings as to whether electrical facilities should be placed underground as a means to avoid widespread outages during major storms. The Commission and the Public Staff decided that reasonable answers to these questions required a studied comparison of costs and benefits. This Report by the Public Staff makes the required cost-benefit analysis and makes certain recommendations regarding these issues.

**Robert P. Gruber, Executive Director**  
4326 Mail Service Center, Raleigh, North Carolina 27699-4326 • 919/733-2435 • Fax 919/733-9565

An Equal Opportunity / Affirmative Action Employer

Secretary Beatty  
November 21, 2003  
Page Two

The Public Staff welcomes any comments that your and other members of the Task Force may have regarding this Report. Please feel free to call on us for any additional explanation or assistance, as we remain committed to working with you for the duration of the Task Force's tenure.

Respectfully submitted,

A handwritten signature in black ink, appearing to read "Robert P. Gruber", with a stylized flourish at the end.

Robert P. Gruber  
Executive Director, Public Staff

cc: Senator David W. Hoyle  
Senator R.C. Soles, Jr.  
Representative Harold J. Brubaker  
Representative Drew P. Saunders  
Chair Sanford and Members of the North Carolina Utilities Commission

**REPORT OF THE PUBLIC STAFF  
TO THE  
NORTH CAROLINA NATURAL DISASTER  
PREPAREDNESS TASK FORCE**

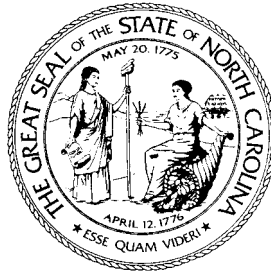

**THE FEASIBILITY OF PLACING  
ELECTRIC DISTRIBUTION FACILITIES  
UNDERGROUND**

**NOVEMBER 2003**

# **TABLE OF CONTENTS**

Page No.

I.	Executive Summary .....	1
II.	Electrical Power Delivery Systems.....	3
III.	The Utilities' Power Delivery Systems.....	12
IV.	Comparison of Overhead to Underground.....	15
V.	Conversion from Overhead to Underground.....	26
VI.	Financing Underground Facilities.....	33
VII.	Conclusions.....	39

Appendix

## I. Executive Summary

In early December 2002, a major ice storm blanketed much of North Carolina with up to one inch of ice, causing an unprecedented power outage to approximately two million electric utility customers. In the immediate aftermath of the storm, the public expressed considerable interest in burying all overhead power lines in the state. The Public Staff responded by investigating the desirability and feasibility of converting the existing overhead lines of the state's three investor-owned electric utilities – Duke Power (“Duke”), Progress Energy Carolinas (“Progress Energy”), and Dominion North Carolina Power (“Dominion”) (collectively, “the Utilities”)<sup>1</sup> – to underground. Since the majority of the damage sustained in severe weather events usually involves distribution rather than transmission lines, the Public Staff's investigation focused on undergrounding this portion of the electrical power delivery system. The primary purpose of this report is to present the results of that investigation.

The investigation consisted of (1) comparing the operational advantages and disadvantages of overhead and underground power distribution systems; (2) estimating and comparing the capital costs of converting overhead lines to underground, along with the differences in operation and maintenance (O&M) costs for the two types of systems; (3) estimating the time and human resources required to bury underground lines; (4) identifying potential additional costs to customers, municipalities, and other utilities that may result from conversion; and (5) exploring options for financing conversion projects.

---

<sup>1</sup> The Utilities Commission has limited jurisdiction over electric cooperatives and municipal utilities.

The Utilities provided valuable assistance throughout the investigation, and the Public Staff gratefully acknowledges their contribution to this report.

The Public Staff has determined that replacing the existing overhead distribution lines of the Utilities with underground lines would be prohibitively expensive. Such an undertaking would cost approximately \$41 billion, nearly six times the net book value of the Utilities' current distribution assets, and would require approximately 25 years to complete. The ultimate impact of the capital costs alone on an average residential customer's monthly electric bill would be an increase of more than 125%. Rates would also be impacted by the higher O&M costs associated with direct-buried underground systems, particularly in urban areas, where underground conductors are four times more costly to maintain than overhead facilities. In addition to the impact on the cost of providing utility service, conversion to underground would impose costs on individual customers, municipalities, and other utilities. While these costs have not been quantified, they could be significant.

The Public Staff has also determined that underground facilities are not without their disadvantages. Although underground systems are more reliable than overhead systems under normal weather conditions, they are not impervious to damage, and the repair time for underground systems is almost 60% longer than for overhead systems when damage does occur. Consequently, the Public Staff does not recommend that the Utilities undertake the wholesale conversion of their overhead distribution systems to underground.

The Public Staff does recommend, however, that each of the Utilities (1) identify the overhead facilities in each region it serves that repeatedly experience reliability

problems based on measures such as the number of outages or number of customer-hours out of service, (2) determine whether conversion to underground is a cost-effective option for improving the reliability of those facilities, and, if so, (3) develop a plan for converting those facilities to underground in an orderly and efficient manner, taking into account the outage histories and the impact on service reliability. Such a plan might include a policy similar to that of Dominion Virginia Power of annually identifying the “worst 10 circuits” and “worst 10 devices” in each of its regions and taking appropriate steps to improve or replace each of these circuits and devices.

In the meantime, the Public Staff recommends that the Utilities continue their current practices of (1) placing new facilities underground when the additional revenues cover the costs or the cost differential is recovered through a contribution in aid of construction, (2) replacing existing overhead facilities with underground facilities when the requesting party pays the conversion costs, and (3) replacing overhead facilities with underground facilities in urban areas where factors such as load density and physical congestion make service impractical from overhead feeders.

## **II. Electrical Power Delivery Systems**

In order to understand the issues associated with burying a power delivery system, it is important to be familiar with the various components of the system from the power plant to the meter. These components are shown on Figure 1.



**Figure 1: Typical Electrical Power Delivery System**

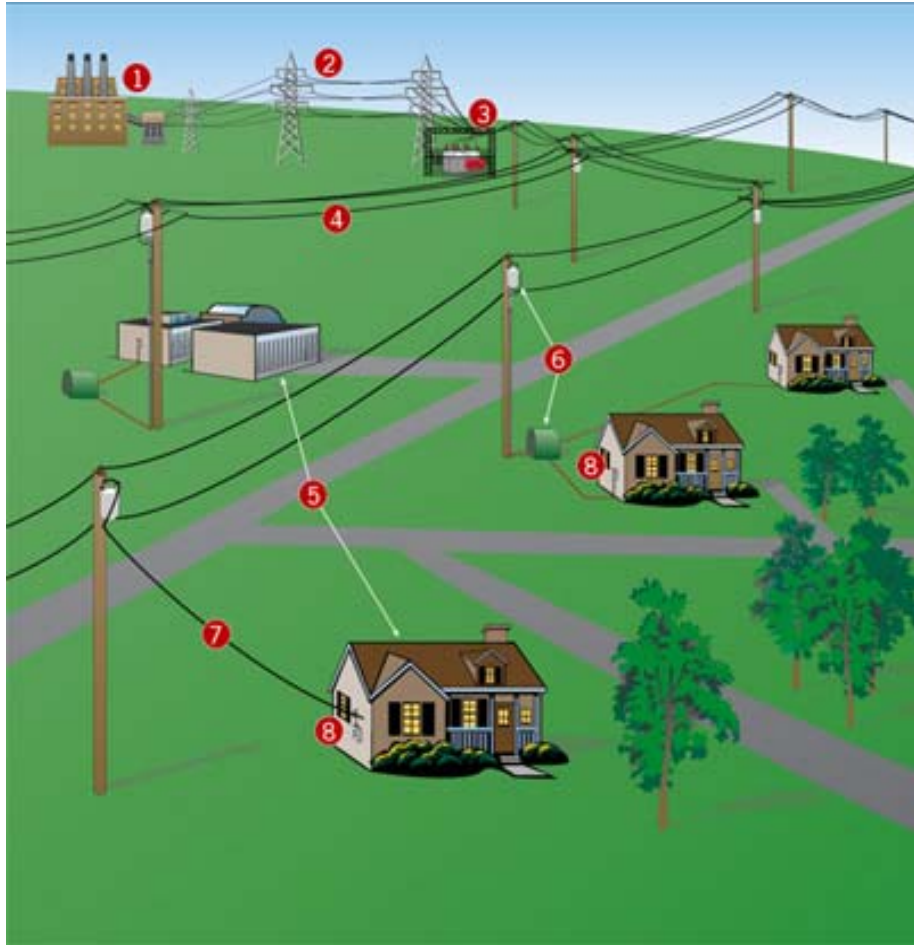

Source: [www.dukepower.com](http://www.dukepower.com)

Electrical power is typically produced at a generating station (1) using nuclear or fossil fuels or, possibly, at a hydro plant. The power generated is three-phase alternating current (AC) power. Once the power is generated, it leaves the generating station and enters a nearby transmission substation where it is converted to high voltages, usually from 115,000 to 500,000 volts, for long-distance transport on the transmission grid.

Transmission lines (2) are the high voltage lines that deliver electricity from the transmission substation to the distribution substation (3). Transmission lines can be thought of as the interstate highways of the power delivery system, while distribution

lines are the local roads and city streets. From the transmission lines the power enters a distribution substation where the voltage is lowered or “stepped down” to distribution level voltages (typically 12,000 to 35,000 volts). The distribution substation also has the capability to route distribution power in multiple directions, and it may have circuit breakers and switches that allow lines to be separated or disconnected from the grid as necessary.<sup>2</sup>

As it leaves the distribution substation, the three-phase power travels along distribution feeder lines (4), which usually follow main roads. Branching off these main distribution feeder lines are tap lines running along side streets through neighborhoods to homes and businesses (5). Since most household appliances and commercial office equipment utilize single-phase power and lower voltages (120 to 480 volts), transformers are required. These transformers (6) are mounted on poles near the premises for overhead service or in green “boxes,” referred to as padmounted transformers, at ground level for underground service (see Figures 2 and 3). From the transformer the electricity enters the residence or building through what is often referred to as the service drop (7), consisting of insulated wires, either overhead or underground, and a watt-hour meter (8).<sup>3</sup>

---

<sup>2</sup> Brain, Marshall, How Power Distribution Grids Work, retrieved May 20, 2003, from <http://people.howstuffworks.com/power.htm>; Delivering Electricity, retrieved May 20, 2003, from <http://www.dukepower.com>.

<sup>3</sup> Delivering Electricity, retrieved May 20, 2003, from <http://www.dukepower.com>.

**Figure 2: Typical Pole-mounted Transformer**



**Figure 3: Typical Padmounted Transformer**



Many types of protective devices are used on a distribution system to improve safety and prevent damage from overloads and electrical faults (short circuits). The most common line protection devices are reclosers, circuit breakers, and fuses. Reclosers are generally utilized on overhead systems, while fuses are used on underground systems because underground faults are usually more permanent than overhead faults. When a fault is detected, these devices operate automatically to isolate the problem area from the rest of the system while maintaining power to as many customers as possible.

**Figure 4: Recloser**



**Figure 5: Bayonet Fuse in Padmounted Transformer**



A recloser opens when it senses a fault on the line and then recloses after a brief waiting period (see Figure 4). This allows temporary faults (e.g., conductors swinging together briefly or tree limbs making momentary contact with conductors during a storm) to clear automatically and prevents a long-term outage due to a temporary condition. Most reclosers are set to "trip" open and reclose two or three times before permanently locking the circuit open and disrupting service to customers for an extended period. Once the recloser locks out, the fault must be cleared before the recloser can be manually reset. Circuit breakers, generally located in distribution substations, function the same way as reclosers.

Like a recloser, a fuse opens when it senses a fault on the line, interrupting current flow to the fault. For line fuses, the insulated mounting device is usually an open-type cutout. The fuse melts when the current heats it beyond a specified limit and causes the cutout to drop open, which provides visible evidence of a problem. In underground switches and transformers, fuses de-energize and isolate the equipment

when faults occur. These fuses can also be used as loadbreak devices for maintenance and repair. In transformers, these fuses are known as “bayonet” fuses (see Figure 5).

Most conductors (lines) are made of aluminum, although some older copper conductors are still in service. Because overhead conductors generally use air as insulation, they must be installed with adequate clearance from other objects. The exceptions are service drops and tree wire, which are insulated for protection against contact with trees and customer facilities. All underground conductors or cables must be insulated because they are buried in the ground. This environment also requires additional protection from moisture, abrasion from rocks and soil, corrosion, and public dig-ins.

The standard design for overhead distribution in a residential area is a radial layout, which can be likened to the spokes of wheel with the substation as the hub. The hardware consists of distribution lines attached to wooden poles and supported either by wooden crossarms or by armless construction. In more densely populated areas, a single overhead transformer may supply service to several homes. In more rural areas, there may be only one service per transformer. Connections of overhead conductors are made with simple mechanical connections (bolt-on, compression, etc.). As more residences are added, the line extends to feed additional transformers. Figure 6 shows a typical arrangement used with overhead distribution.

**Figure 6: Typical Arrangement for Overhead Distribution (Radial Design)**

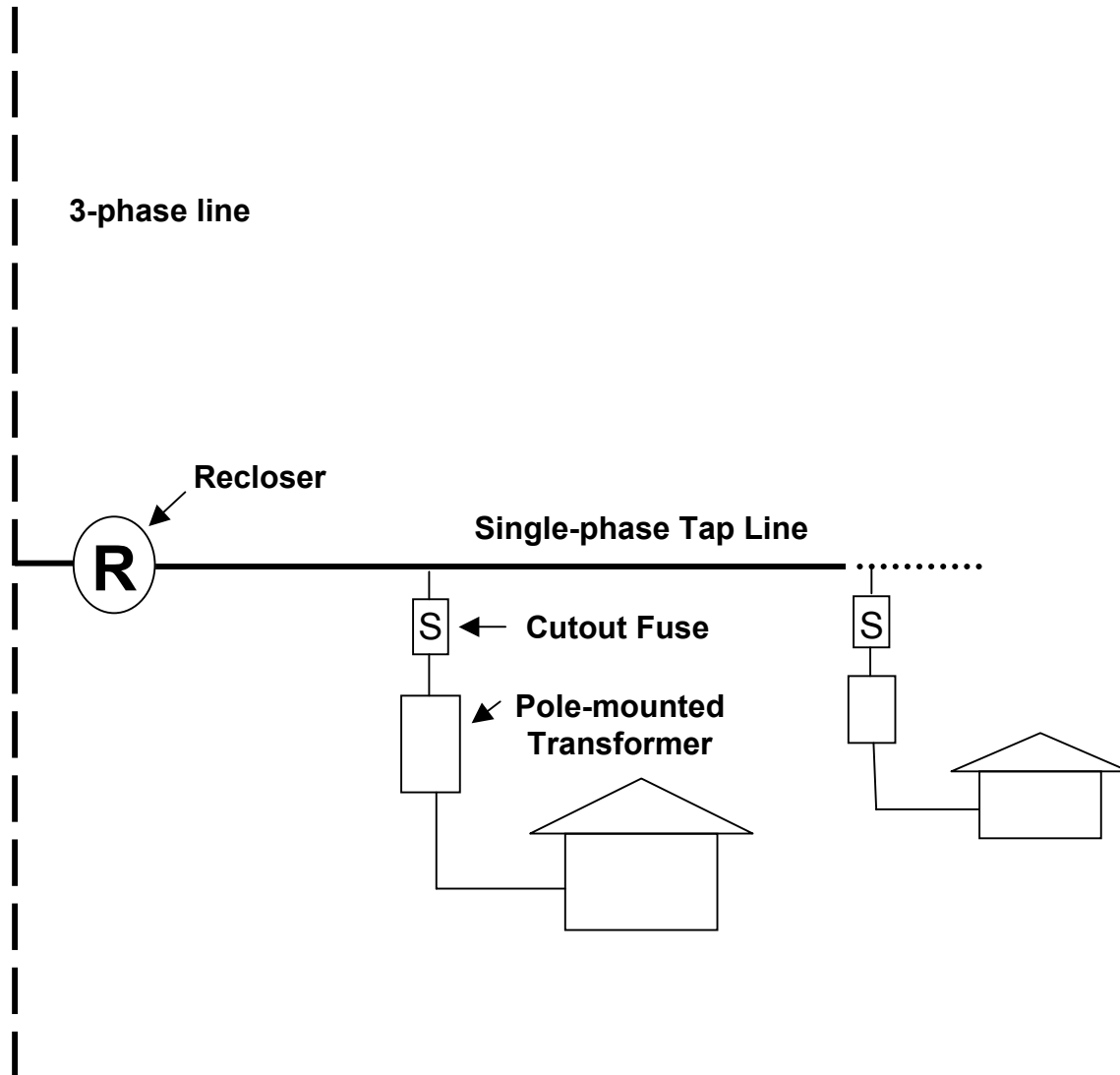

When outages occur, utility personnel narrow their search for the problem according to the particular protecting device that operated. For example, if a recloser opens, the problem is somewhere on the line. Customers receiving service from a portion of the line beyond the fault are usually interrupted until the necessary repairs are made. If the fault is as simple as a broken wire, it can usually be spliced and service can be restored fairly quickly. If a transformer fails, the fused cutout drops open and service is interrupted to all customers served by the affected transformer.

Underground residential distribution is composed of primary cables connected to overhead lines at terminal poles. The cable becomes the supply to individual padmounted transformers. As with an overhead system, the padmounted transformers serve several residences in densely populated areas and fewer residences in the more rural areas. Because of the time and difficulty of locating faults on underground distribution, the preferred design incorporates an open loop arrangement (permitting supply from two directions). Thus, when a cable fails, the faulted section is first identified and the sectionalizing point<sup>4</sup> allows the faulted section to be isolated until service can be restored. Figure 7 shows the typical design for underground distribution.

---

<sup>4</sup> The sectionalizing point in primary electric loop circuit configurations is a normally open switch. Closing this switch after a fault develops along the loop, allows loads to be "back fed" or re-energized until the fault can be located and repaired. This allows the utility to minimize the number of loads without power. Once the fault is repaired, the switch at the sectionalizing point is opened and remains so until the next failure.

**Figure 7: Typical Underground Distribution Arrangement  
(Open Loop Design)**

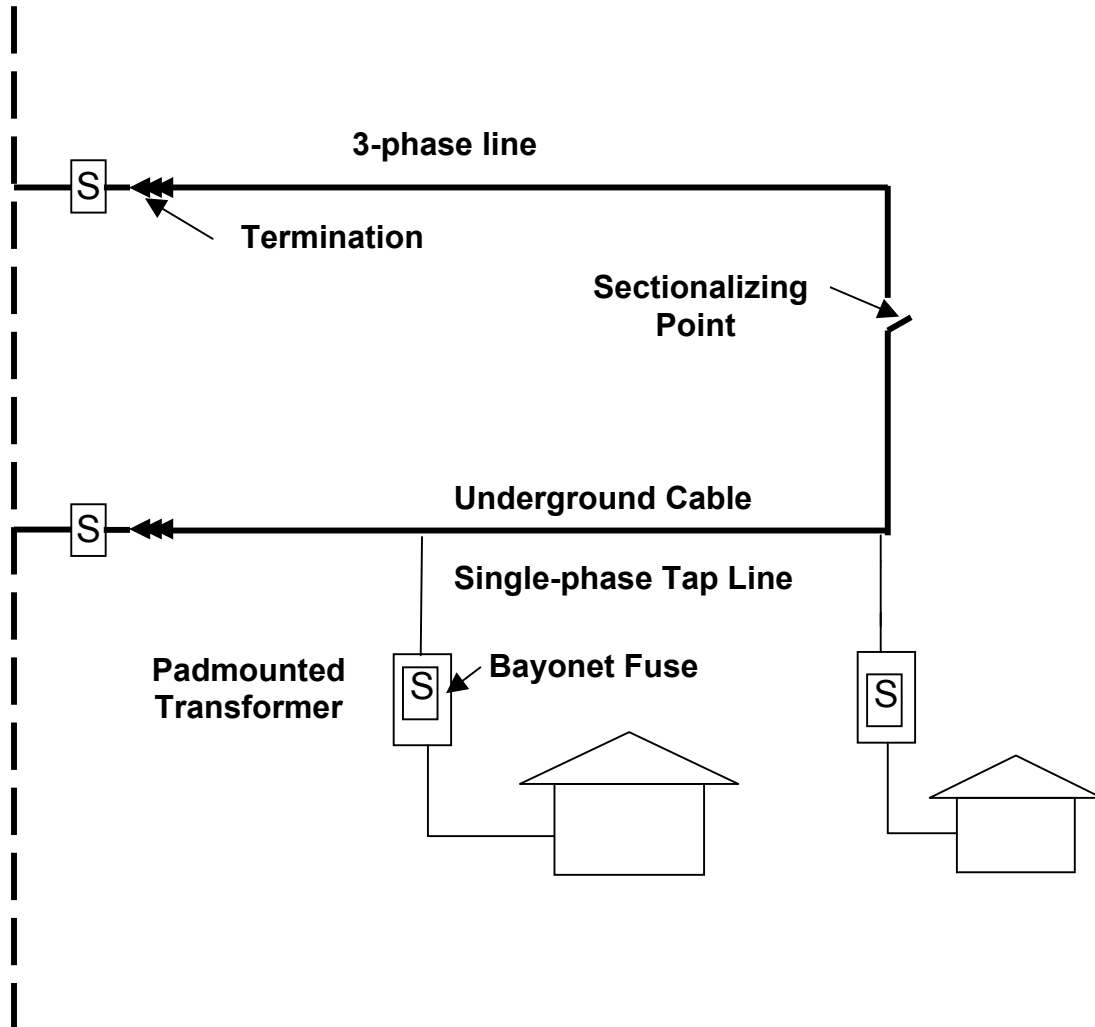

Specialized fault-locating radar is used to locate cable faults in an underground system. The faulted cable section is then isolated between two transformers, and service is restored by switching some of the customers to the alternate path. In this type of open loop configuration, the actual cable repair is normally done later by special crews. In areas that are not looped, all customers beyond the protective device will remain out of service until the fault is located and repaired.



### III. The Utilities' Power Delivery Systems

Duke, Progress Energy, and Dominion provide electricity to more than 2.7 million customers and serve 47,777 square miles of the total 52,672<sup>5</sup> square miles within North Carolina's borders. They have 13,617 miles of transmission power lines and 88,760 miles of distribution power lines in the state.

Duke serves almost 1.5 million customers in North Carolina, and 2.2 million customers system wide. Its service territory stretches from the Virginia border south to Georgia, covering 24,138 square miles system wide and 15,777 square miles in North Carolina.

**Figure 8: Duke's Service Territory**

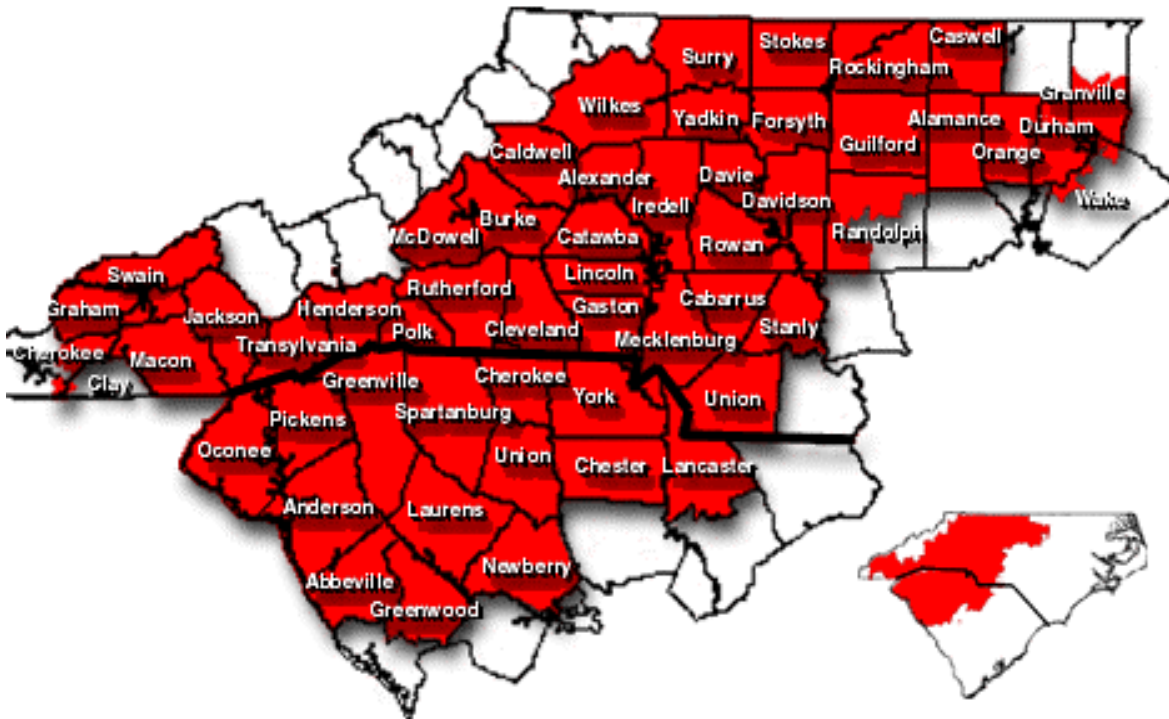

Provided by Duke

<sup>5</sup> Log Into North Carolina, retrieved May 19, 2003, from [http://data.osbm.state.nc.us/pls/linc/dyn\\_linc\\_main.show?p\\_arg\\_names=module&p\\_arg\\_values=states](http://data.osbm.state.nc.us/pls/linc/dyn_linc_main.show?p_arg_names=module&p_arg_values=states).

Duke's electrical power delivery system in North Carolina contains 7,718 miles of transmission line, 36,000 miles of overhead distribution line and 10,000 miles of underground distribution line. Of Duke's 7,718 miles of transmission line, only 2.54 miles are underground.

Progress Energy serves 1.1 million customers in North Carolina and 1.3 million customers system wide. Its service territory includes much of eastern North Carolina, northeastern South Carolina, and the Asheville area in western North Carolina, covering 34,000 square miles system wide and 29,000 square miles in North Carolina.

**Figure 9: Progress Energy's Service Territory**

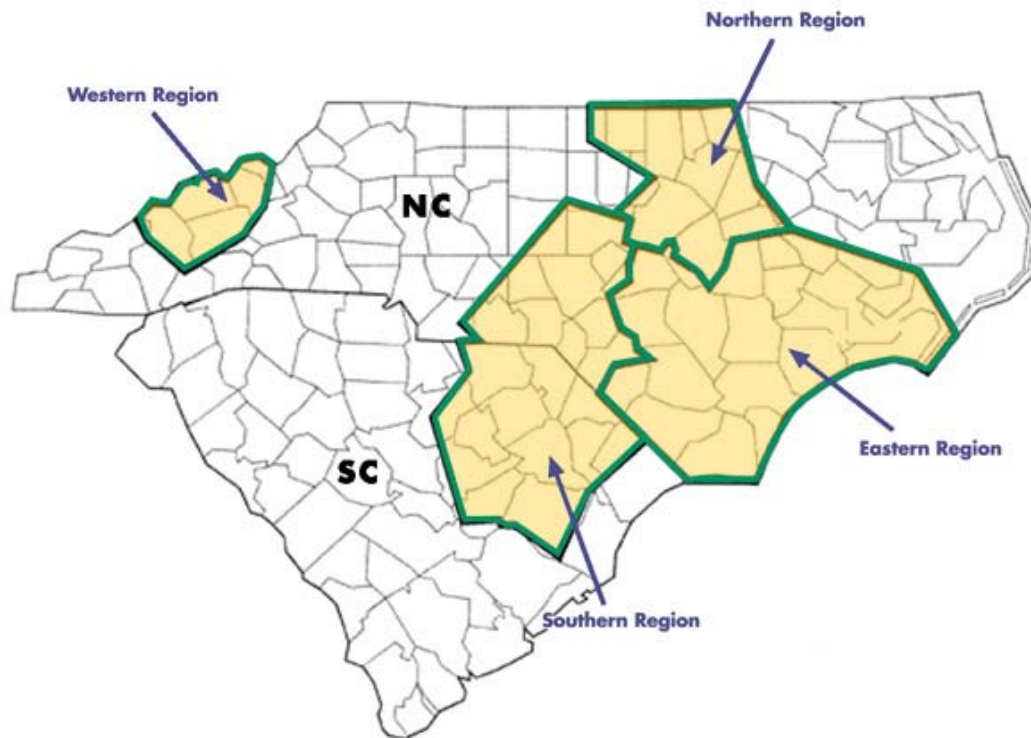

Provided by Progress Energy

Progress Energy's electrical power distribution system in North Carolina contains 5,024 miles of transmission power lines, all of which are overhead. Its distribution network is made up of 28,000 miles of overhead and 10,000 miles of underground line.

Dominion serves approximately 115,000 customers in northeast North Carolina.

**Figure 10: Service Territories of Dominion North Carolina Power and Dominion Virginia Power**

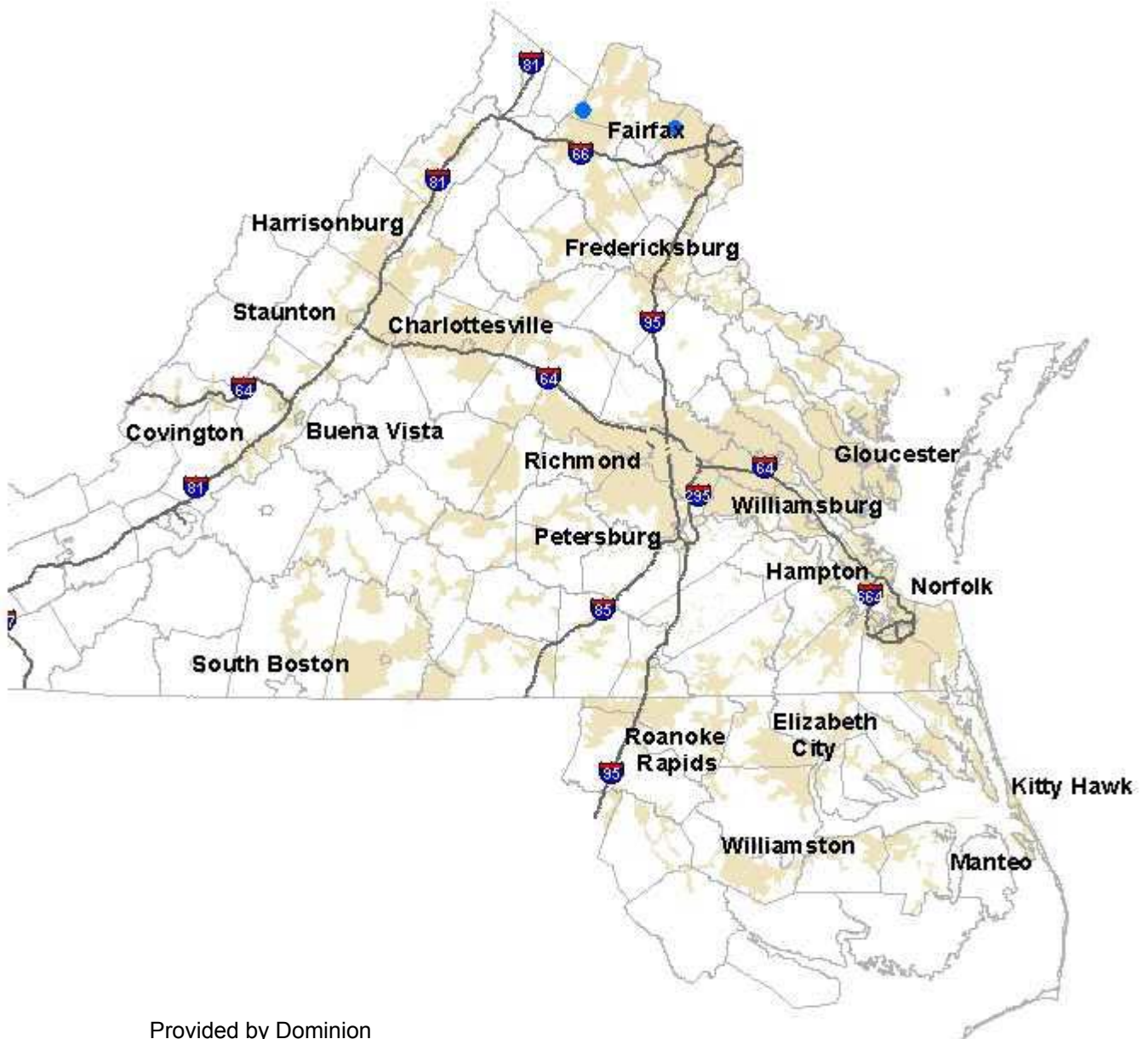

Provided by Dominion

Its service area comprises roughly 3,000 square miles along the Virginia border and the Outer Banks. Dominion's electrical power delivery system contains 875 miles of transmission line, all overhead. Its distribution system is composed of 4,131 miles of overhead and 629 miles of underground line.

#### **IV. Comparison of Overhead to Underground**

In the 1960s, cities such as Paradise Valley, Arizona, and Palo Alto, California, adopted ordinances requiring that all new utility lines be placed underground. Many municipalities have adopted similar ordinances since that time. From the outset, the most significant issue associated with undergrounding has been the high cost of burying power lines. Current cost estimates for such projects range from \$500,000 to \$3,000,000 per mile compared to \$120,000 per mile for installing overhead lines.<sup>6</sup>

Many reasons have been given for burying power lines. These include reduced maintenance, smaller rights of way, less susceptibility to weather damage, fewer traffic accidents involving poles, improved aesthetics, and increased property values. The primary reason against burying power lines has been the high cost. Underground lines cost more to install than overhead lines. The design is more complex, the materials are more expensive, and installation takes longer for underground lines. Moreover, installation can damage root systems of nearby trees. Maintenance costs are higher for underground lines, and specialized training is required. The cost of modification, expansion, or replacement is also higher. Problems are harder to locate and repairs can take longer. Underground lines are not impervious to damage; they are vulnerable to dig-ins and can sustain water damage.

---

<sup>6</sup> "Utility Undergrounding Programs," Sciencetech, Inc., April 11, 2001.

The Public Staff has examined the reliability differences between underground and overhead lines, reviewed cost estimate ranges for several different types of undergrounding projects, and compared O&M costs and work practices associated with overhead and underground lines.

**Reliability**

In order to compare the reliability of an underground system to an overhead system, the Public Staff obtained average reliability data from the Utilities for the last five years. These data are for normal conditions only and exclude outages due to major storms. The combined data are shown in the table below.

**Table 1: Reliability Data for Overhead and Underground Systems  
(Per Year Basis)**

Category	Overhead System	Underground System
System interruption rate (per mile)	0.57	0.30
Tap line interruption rate (per mile)	0.35	0.17
Average outage duration (in minutes)	92	145
Individual service conductor interruptions (per 1,000 customers)	9.7	9.6

As the data demonstrate, underground systems are more reliable than overhead systems during normal weather conditions. Based on five years of reliability data, the Utilities experienced an average annual system rate of 0.57 interruptions per mile of overhead line compared to 0.30 interruptions per mile of underground line; tap lines alone had an average annual interruption rate of 0.35 and 0.17 per mile for overhead and underground systems, respectively. Thus, an overhead system suffered almost twice the number of interruptions as an underground system during this period. However, the data also demonstrate that the typical underground outage takes 145 minutes to repair compared to 92 minutes for an overhead outage. In other words, an underground system will suffer only about half the number of outages of an overhead system, but those outages will take approximately 58 percent longer to repair and may involve digging up a front yard, sidewalk, or street.

Underground electrical distribution systems are also naturally resistant to problems during severe weather and, therefore, provide more reliable service. However, flooding, objects falling on surface-mounted equipment, and over-voltages caused by lightning can all cause the loss of power during a storm. In addition, long-term system outages such as those associated with major storms may allow moisture to seep in, and this moisture can cause the cable to fail once the system is re-energized. Thus, while underground distribution lines will reduce the number of outages experienced during normal weather and limit the damage to the electrical distribution system from severe weather-related events, they are not invulnerable.

## **Life Expectancy**

A well-maintained overhead system has a life expectancy of more than 50 years, primarily because individual components are easy to replace. The life expectancy of underground cable installed today is thought to be greater than 30 years. However, other components of the system, such as surface-mounted equipment, may have less than 30 years of useful life.

## **Capital Costs**

In order to determine the range of costs and labor requirements associated with various types of undergrounding projects, the Public Staff obtained cost estimates from each of the Utilities for a variety of underground conversion projects, as well as the costs and labor requirements for the installation of underground lines in a residential subdivision and a commercial shopping center project on a previously undeveloped, or “greenfield,” site. The types of projects included an urban downtown district, a suburban commercial area, a suburban residential area, a rural bulk feeder circuit, a rural tap circuit, and residential service drops in suburban and rural areas.

To ensure that the cost estimates were based on realistic conditions, actual facilities maps were provided to the Utilities. Each map illustrated the size, location and density for the undergrounding project. For consistency several of the possible assumptions associated with each type of project were also provided. Those assumptions are listed in Appendix A. Each utility based its estimates on typical design and construction practices as well as field conditions in its franchised service territory. The cost estimate ranges for conversion projects are shown in Table 2, the labor

estimate ranges in Table 3, and the costs for greenfield projects in Table 4. All averages are based on the estimates provided by the Utilities.

**Table 2: Conversion Costs per Mile**

Type of Facility	Urban	Suburban	Rural
<b>Heavy Commercial District/Boulevard*</b>	\$3,000,000 (max.) \$1,314,000 (min.) <b>\$2,053,000 (avg.)</b>	Not Applicable	Not Applicable
<b>Three Phase Bulk Feeder</b>	Included Above	\$2,770,000 (max.) \$ 893,000 (min.) <b>\$1,520,000 (avg.)</b>	\$994,000 (max.) \$370,000 (min.) <b>\$590,000 (avg.)</b>
<b>Three Phase Primary Tap</b>	Included Above	\$1,680,000 (max.) \$ 518,000 (min.) <b>\$ 938,000 (avg.)</b>	\$775,000 (max.) \$200,500 (min.) <b>\$456,000 (avg.)</b>
<b>Single Phase Primary Tap</b>	Not Applicable	\$ 438,000 (max.) \$ 220,000 (min.) <b>\$ 350,000 (avg.)</b>	\$290,000 (max.) \$151,000 (min.) <b>\$218,000 (avg.)</b>
<b>Residential Service Drops (cost per service)</b>	Not Applicable	\$ 2,333 (max.) \$ 923 (min.) <b>\$ 1,481 (avg.)</b>	\$ 3,977 (max.) \$ 1,432 (min.) <b>\$ 2,346 (avg.)</b>

\* The estimates for converting a heavy commercial urban district are based on actual projects recently completed by the Utilities.



**Table 3: Conversion Man-hours per Mile**

Type of Facility	Urban	Suburban	Rural
<b>Heavy Commercial District/Boulevard</b>	10,244 (max.) 4,910 (min.) <b>9,500 (avg.)</b>	Not Applicable	Not Applicable
<b>Three Phase Bulk Feeder</b>	Included Above	9,975 (max.) 4,910 (min.) <b>7,442 (avg.)</b>	4,681 (max.) 1,020 (min.) <b>3,218 (avg.)</b>
<b>Three Phase Primary Tap</b>	Included Above	9,267 (max.) 3,030 (min.) <b>6,150 (avg.)</b>	3,948 (max.) 1,250 (min.) <b>2,727 (avg.)</b>
<b>Single Phase Primary Tap</b>	Not Applicable	3,780 (max.) 1,365 (min.) <b>2,572 (avg.)</b>	2,248 (max.) 925 (min.) <b>1,458 (avg.)</b>
<b>Services (cost per service)</b>	Not Applicable	10 (max.) 10 (min.) <b>10 (avg.)</b>	19 (max.) 13.6 (min.) <b>15.8 (avg.)</b>

The data in Tables 2 and 3 indicate that the estimated costs and man-hours required for converting from an overhead to an underground circuit vary significantly. These differences can be attributed to assumptions about field conditions, anticipated growth, work methods, engineering design, and material utilized. This is not surprising given the fact that the designers were unable to visit actual locations, and their assumptions were based on individual experience.

The cost estimates provided by the Utilities give an indication of some of the parameters that significantly affect the cost of an undergrounding project. For example, driveways and roads require directional boring or pavement removal and replacement, which increases the labor cost significantly, whereas the ability to dig a trench and bury the line without any hindrance allows for lower cost construction. Similarly, high growth areas where future circuits or rework are anticipated may require a concrete-encased conduit system called a duct bank,<sup>7</sup> which means significantly higher material and labor costs. In contrast, projects in rural, low growth areas may cost less because less design allowance for growth is required and less expensive cable can be installed, often without conduit.

Another cause of the high cost of undergrounding is the provision of a loop feed back to the electricity source. This loop feed is needed because of the extensive repair time associated with underground cables. Rather than risk exposing the customers to extended outages, the system is installed to allow feeding from an alternate direction so that only a portion of the loop will be out of service while repairs are being made.

Soil conditions also greatly impact the cost of undergrounding. In North Carolina, soil conditions vary significantly as the terrain changes from the mountains to the coast. Abnormal construction conditions, such as burying lines in solid rock, wetlands, rivers, quicksand culverts, or areas with a high water table, are not included in the costs given above and will substantially increase the cost of underground projects if encountered.

---

<sup>7</sup> Duct bank systems are identified by one or more underground conduits or ducts (which may be encased in concrete) designed to contain underground cables. The conduit ducts are arranged in the form of a gallery or cable tunnel.

The availability of cleared right-of-way for the placement of equipment and the installation of cable also significantly affects the cost of an undergrounding project. For example, one estimate utilized in Table 2 for the conversion of a suburban district assumed that there was no feasible place to install the power lines except under the existing roadway. This estimate required that the underground lines be placed in a duct bank under the pavement of the road at an additional cost of approximately \$1,000,000 per mile. This constraint also heavily impacted the labor hours required because of the extra labor needed to remove and replace the pavement and the additional personnel required to direct traffic in the work zone. Indeed, most conditions and designs that lead to higher underground installation costs also lead to increased labor requirements, and most of the reasons given for the variation in cost for a particular type of project also apply to the variation in labor requirements shown in Table 3.

In addition to estimating conversion costs and labor requirements, each utility was requested to estimate underground installation costs to serve two types of new or greenfield developments: a commercial shopping center, based on an actual drawing, and a residential subdivision of 99 lots, with homes ranging from 2,200 to 2,400 square feet. The results of these estimates are shown in Table 4 below.

**Table 4: Greenfield Underground Costs per Mile**

<b>Type of Facility</b>	<b>Construction Cost</b>
<b>Commercial Shopping Center</b>	\$220,000 (max.) \$142,000 (min.) <b>\$174,000 (avg.)</b>
<b>Residential Subdivision</b>	\$69,000 (max.) \$39,000 (min.) <b>\$54,000 (avg.)</b>

Thus, the costs of serving newly developed, greenfield areas with underground are substantially less than the cost of converting existing overhead areas to underground. In addition, since such areas are planned, it is easier to predict future electrical needs and minimize concerns with growth and changes. While costs vary with environmental conditions, load density, system complexity, engineering design, and materials used, the range is much smaller than for conversion projects. One noteworthy exception involves large multi-use developments, such as those found in urban areas, where the cost of underground bulk feeders and switches is substantial.

#### **Operation and Maintenance Costs**

In order to compare annual operation and maintenance (O&M) costs associated with overhead and underground power distribution systems, the Utilities were asked to provide their O&M costs per mile for both types of systems. These data are shown below in Table 5 and are based on three-year averages.

**Table 5: O&M Costs for Overhead and Underground Distribution Systems**

	<b>Overhead O&amp;M (\$/mile)</b>	<b>Direct-buried Underground O&amp;M (\$/mile)</b>	<b>Duct Bank Urban Underground O&amp;M (\$/mile)</b>
High	\$1,064	\$1,160	\$6,404
Low	\$757	\$614	\$1,700
<b>Average</b>	\$917	\$920	\$4,052

These costs include maintenance and repair, preventive maintenance, and service restoration. Both types of systems require equipment inspection. In addition, overhead systems require tree trimming, wildlife protection, and line patrolling, while underground systems require cable locating. Tree trimming is one of the most costly activities for an overhead system. Costs of \$7,000 to \$70,000 per mile are possible depending on the size and height of trees, number of trees removed per mile, accessibility by necessary equipment, and whether the work is in rural or urban locations.

Duct bank systems are significantly different from underground distribution systems used for residential customers, and therefore the costs are shown separately. Such systems are found mostly in larger cities to serve commercial loads, and they require that the cables be placed in concrete ducts and the transformers in underground vaults. The wide variation of annual O&M costs associated with duct bank systems can be attributed to the types of systems most common to each utility. The lower O&M

figure (\$1,700/mile) was based on downtown areas served by spot and grid networks. The higher figure was based on the use of automatic transfer<sup>8</sup> switches in both a downtown area and a major office complex area.

The data in Table 5 show that the O&M costs per mile for an overhead system and a direct-buried underground system are comparable. However, the annual average O&M cost per mile of an urban underground system that requires installation in duct bank is more than four times that of an overhead system.

### **Operational Impacts**

An overhead distribution system is more flexible than an underground system. For example, tapping an overhead line to serve additional load is a relatively easy and low-cost task. It involves making an electrical connection to the line, running additional wire to the desired transformer location, and installing a new transformer. Tapping an underground cable is much more complicated, time consuming, and costly. The cable must be cut and spliced somewhere along the loop, followed by the installation of complex rubber insulated elbow connectors to tie into the transformer. The new cable must be buried as well.

Reconfiguration is a continual and fairly simple process with overhead distribution. As load grows, portions of circuits are frequently “switched over” to adjacent circuits to help balance the loads, delaying the need for additional lines and substations. With underground distribution, open points and terminations in the system are fixed, and it is usually extremely difficult to alter the original arrangement. Similarly, since most “taps” or branch circuits usually start out as single-phase circuits, it is quite

---

<sup>8</sup> An automatic transfer switch is self-acting equipment for transferring one or more load conductor connections from one power source to another.

common to serve load growth by adding an additional phase or two (i.e., by installing crossarms and additional wire) to overhead circuits. With underground circuits, it is much more difficult and expensive to go back and install additional cable.

In addition, most underground crews receive specialized training in splicing and terminating cable, and most utilities maintain underground crews whose specialty is locating cable faults. These crews receive extensive training on fault locating equipment. Because this equipment continues to evolve, training is an ongoing process.

## **V. Conversion from Overhead to Underground**

Using the data presented in Section IV of this report, the Public Staff has estimated the capital costs, time, and man-hours needed to convert the Utilities' overhead electrical distribution systems to underground. These estimates are very rough and should not be used to determine actual costs for a particular project. Further refinement would require years of engineering design and study, as each undergrounding project is unique and must be analyzed in detail to determine its specific requirements.

### **Costs to Utilities and Their Customers**

First, the capital costs developed in Section IV were condensed to obtain an average cost per mile for undergrounding (1) a line in a heavily commercial urban area, (2) a three-phase suburban line, (3) a three-phase rural line, and (4) a single-phase line. Each of the Utilities was then asked to estimate the total miles of each type of overhead distribution line on its system. Multiplying the average cost times the number of miles for each type of line and summing the results yields an estimated cost of almost \$41

billion to bury the 68,275 miles of overhead distribution line currently owned by the Utilities in North Carolina.<sup>9</sup> This is almost six times the Utilities' current total investment in distribution plant of \$7.36 billion.<sup>10</sup>

Table 6 contains a summary of conversion costs by type of line.

**Table 6: Summary of Conversion Costs by Line Type**

Type of Line	Miles of Line	Cost per Mile	Total Cost (Billions)
Heavy/Commercial Urban	3,004	\$2,053,000	\$6.2
Three-phase Suburban	13,129	\$1,229,000	\$16.1
Three-phase Rural	15,296	\$523,000	\$8.0
Single-phase	36,846	\$284,000	\$10.5
<b>Total</b>	68,275	Not Applicable	\$40.8

Using the extra facilities charge and total kilowatt-hour sales for 2002, the Public Staff estimated that an additional \$41 billion investment would increase the Utilities' combined annual revenue requirement by \$8.8 billion and have a rate impact of

<sup>9</sup> The estimate to bury the overhead distribution lines owned by the Utilities does not include the costs associated with burying the distribution lines owned by the electric cooperatives and the municipalities in North Carolina.

<sup>10</sup> 2002 FERC Form 1 filed with the Utilities Commission.



approximately 10 cents per kWh. With average rates of 7.77 cents per kWh for residential service, 6.15 cents per kWh for commercial service, and 4.63 cents per kWh for industrial service, an additional 10 cents per kWh would increase residential rates by 128.7%, commercial rates by 162.6%, and industrial rates by 215.98%. The average bill of a residential customer using 1,000 kWh per month would increase from \$77.70 to \$177.70 per month.

Using a similar methodology, the Public Staff estimated that it would require over 237,000,000 man-hours to convert all the overhead distribution lines of the Utilities to underground. In other words, assuming that the workers currently employed by the Utilities to bury power lines continued working on new undergrounding projects, and that the Utilities collectively hired nearly 5,000 new employees to bury existing power lines, it would take 25 years to complete the task.

For a perspective on the impact of lesser levels of investment in underground facilities, Table 7 shows the average bill increases for residential customers using 1,000 kWh per month and an average bill of \$77.70 associated with levels of investment ranging from \$1 billion to \$40.8 billion.

**Table 7: Residential Rate Impact  
(Using 1,000 kWh/Month)**

<b>Construction Cost</b>	<b>Monthly Rate Impact</b>	<b>Monthly Percent Increase</b>
\$1,000,000,000	\$2.34	3.01%
\$5,000,000,000	\$11.71	15.06%
\$10,000,000,000	\$23.43	30.12%
\$15,000,000,000	\$35.14	45.19%
\$20,000,000,000	\$46.85	60.25%
\$25,000,000,000	\$58.57	75.31%
\$30,000,000,000	\$70.28	90.37%
\$35,000,000,000	\$82.00	105.43%
\$40,000,000,000	\$93.71	120.50%
\$40,767,096,840	\$95.51	122.81%

**Costs to Customers and Municipalities**

Any undergrounding project would involve costs to individual customers in order to make their facilities accept underground service. Service drops (i.e., everything from the transformer to the building) must also be buried, and service entrances must be modified to accept underground lines. The Utilities provided estimates for burying service drops in the cost data provided in Section IV. Those estimates indicate a cost of approximately \$1,500 for undergrounding a 100-foot suburban service drop and \$2,350 for a 250-foot rural service drop. The modifications necessary for the service entrance

would not be made by the utility company and would require the property owner to hire a licensed electrician. The cost would depend on the specifics of each property but is estimated to be around \$400 per residential and small commercial customer.

There may be additional costs if dwellings do not meet current electrical codes, as is often the case with older dwellings. The local municipality may require the property owner to make modifications to bring the dwelling to current code before underground electric service is connected. These modifications would require an electrical permit from the municipality and an electrical inspection upon completion. It should be noted, however, that this issue is primarily a local one, as the State of North Carolina does not require an upgrade to current code merely for the conversion from overhead to underground service.

In addition to the costs to customers, there would be costs to municipalities in order to accomplish a complete conversion to underground service. For instance, municipalities would be responsible for paying for the undergrounding of service to streetlights and traffic signals that are mounted on the electrical service poles.

There are also indirect impacts associated with undergrounding projects. For instance, should a property owner or municipality decide to undertake the burial of distribution lines, the impacts of the trenching must be considered. Burying power lines requires digging large ditches that disrupt existing landscapes, which can impact anything from a flower bed in a front yard to the flow of traffic on a major roadway. If the trenching takes place near existing trees, there is the possibility that root systems will be damaged and eventually weaken or kill the trees. Furthermore, a properly maintained underground right-of-way must be kept clear of trees. Thus, while properly trimmed

trees can grow near overhead power lines, no trees would be permitted in the underground right-of-way. The costs associated, the inconvenience of additional traffic congestion, and the possible loss of trees on an attractive neighborhood street are not easily quantifiable, but they cannot be ignored.

The following photographs of actual undergrounding projects show just how much disorder a property owner may expect from a conversion project.

**Figure 11: Typical Trenching Operation for Residential Services**



**Figure 12: Installing Flexible Conduit in an Open Trench**



**Figure 13: Placing Underground Distribution Cable in an Open Trench**



### **Costs to Other Utilities**

Currently, other utilities, such as telephone and cable television, may share space on poles with the electric service. If the power lines are buried in order to eliminate the utility poles, these other services will also have to be buried. In a report prepared for the Mayor and Town Council of Chapel Hill, North Carolina, the cost for

burying telephone lines owned by BellSouth was estimated informally at \$13.3 million for the 1.6 million feet of aerial cable within the town. The report also estimates the cost of burying cable television services at \$50,000 to \$60,000 per mile.<sup>11</sup> Such costs must also be taken into consideration.

## **VI. Financing Underground Facilities**

Since the costs of installing new underground facilities and converting overhead facilities to underground can be quite substantial, it will be helpful to consider how these costs are distributed among the Utilities, the customers served by the facilities, and other affected parties. All of the Utilities have plans on file with the Commission detailing the terms, conditions, and charges under which they agree to extend distribution service to customer locations.<sup>12</sup> Although distribution facilities are usually installed overhead, each utility will install underground facilities upon request in accordance with its line extension plan. Several options exist for placing facilities underground depending on the utility involved and whether the installation is for an individual customer, a new development, or a conversion of existing overhead facilities to underground.

### **New Underground Facilities**

A new overhead line extension involving secondary, single-phase voltage to individual residential customers is typically provided to a normal point of delivery at no cost to the customer; however, in some cases, there is a charge for providing

---

<sup>11</sup> Stockard, Bill, Preliminary Report Regarding Burial of Town's Utility/Power Distribution System, February 24, 2003.

<sup>12</sup> See Commission Rule R8-24; Progress Energy Carolinas, Inc. Line Extension Plan E-36A; Duke Power Company Underground Distribution Installation Plan; Virginia Electric and Power Company Tariff Section XXII, Electric Line Extensions and Installations.

underground conductors to the home from an overhead source. If any abnormal costs or distances are involved, the customer is responsible for reimbursing the utility for such costs. If extension of primary voltage lines is required, an economic feasibility test is done. This test often involves a comparison of the extension cost to expected revenue over a period of time, such as five or seven years. Construction costs that exceed the revenue projection are charged to the customer. If an underground primary extension is requested, the costs may be included in the revenue comparison calculation, or additional charges may apply based on the higher costs of installing underground facilities.

The provisions for extending service to new developments are similar to the above provisions for individual residential customers. Developers are subject to the application of an economic feasibility test in which the construction costs to extend facilities are compared to some assumed level of revenue over a shorter period of time (often two or three years). The developer is required to pay for any excess of cost over revenues. To recognize the higher cost of providing underground facilities, some utilities use a “cost difference” approach rather than the revenue comparison for the additional cost of underground. Under this approach, the developer pays some or all of the differential in the cost of installing underground versus overhead facilities.

Similar tests apply to the installation of primary distribution feeders, which are often classified as bulk feeders and tap lines. Bulk feeders deliver power directly from a substation to a large geographic area. Tap lines branch off bulk feeders to deliver power to individual subdivisions or streets. Bulk feeders are generally used in overhead

construction. An individual or developer who requests that a bulk feeder be placed underground will be required to pay the cost differential between overhead and underground construction. Subfeeders within a new underground development may be constructed underground at no additional charge or may require some payment by the developer, depending on the circumstances and utility involved. Subfeeders outside such areas will typically be installed overhead unless payment is made for the cost difference between overhead and underground construction. The cost of placing subfeeders underground may be included in the costs used in the revenue comparison test where that approach is used for determining the charges to the individual or developer.

### **Converting Overhead Facilities to Underground**

The charges established in the Utilities' line extension plans for conversions of existing service from overhead to underground vary from one company to another. Progress Energy requires that the customer pay the cost of the underground facilities, plus the depreciated cost of the existing overhead facilities reduced by their salvage value, plus the cost of removing and rearranging the overhead facilities, minus the cost of new overhead facilities. Duke's Underground Distribution Installation Plan provides that "[w]hen the existing overhead distribution system is adequate to serve the customer's load, the [customer payment] shall be equal to the cost of comparable underground facilities, less any salvage value of the overhead system." Dominion's tariff simply states that when the existing facilities provide adequate capacity, the customer requesting conversion to underground must pay "[t]he cost of performing the requested work."



Progress Energy has included a provision in its line extension plans under which it will, upon request, convert overhead facilities to underground without charge in a downtown commercial area, provided the area has sufficient load density. There are specific numerical criteria for load density, expressed in kilowatts of demand per street foot. Generally, only the state's largest cities can meet these criteria. The municipality must agree to receive underground street lighting service and satisfy certain other requirements. The cost of the conversion constitutes an operating expense, and in appropriate circumstances it may be recovered through the ratemaking process, because the conversion serves to avoid the necessity of building the bulky and expensive structures required to support large overhead lines. Duke has not included any provision of this type in its tariffs, but it has advised the Public Staff that in some cases it has converted overhead facilities in downtown areas to underground at its expense. Dominion has adopted a provision authorizing it to designate a "major metropolitan, high-load density center" as an "Underground Distribution Area," but its tariff does not indicate whether it will bury existing overhead lines at its own expense in such an area, nor does it specify numerical load density criteria for designating underground distribution areas. Dominion has stated that its policy is to recover the conversion costs from the entity requesting the conversion.

Because the cost of replacing overhead with underground facilities in a large area is usually quite substantial, local governments have generally been reluctant to request such conversions, except in situations where the utility will bear the cost. In some instances, however, municipalities have been able to negotiate agreements with utilities for burying lines in a specific area in connection with a civic beautification

project. Depending on the circumstances, a utility may be willing to offer a reduced charge because it foresees that it may need to install underground facilities in the area at its own expense at a later time, because it hopes to win recognition for making a contribution to the attractiveness of the city, or for other reasons.

In one instance a local government body sought, over a utility's opposition, to have underground facilities installed at the utility's expense. In the early 1980s the Roanoke Voyages Corridor Commission (RVCC) – an agency created by the General Assembly and given authority to adopt regulations governing property within 50 feet of U.S. 64-264 on Roanoke Island – ordered that all new electric lines within the 50-foot corridor be underground. Virginia Electric and Power Company (Vepco)<sup>13</sup> indicated that it would require customers within the corridor to pay a portion of the costs of underground facilities, in the same way as any other customer. (The U.S. 64-264 corridor on Roanoke Island is not a high-density area where a utility might find it economically attractive to install underground facilities.) The RVCC filed a complaint against Vepco, requesting the Commission to issue a declaratory order holding that Vepco should provide underground service at no cost to customers in the corridor, and that the cost of the service should be treated as an operating expense for ratemaking purposes. The Commission refused to issue such an order, noting that the cost of underground service in the corridor should be borne by the customers who benefited from it, rather than being passed on to the general body of Vepco customers. Its refusal

---

<sup>13</sup> Virginia Electric and Power Company, the regulated utility subsidiary of Dominion Resources, Inc., was formerly (and sometimes informally still is) referred to as Vepco. Currently it uses the business names "Dominion North Carolina Power" and "Dominion Virginia Power" for its North Carolina and Virginia operations, respectively.

was affirmed by the Court of Appeals.<sup>14</sup> Since then, the Roanoke Voyages case has stood for the principle that a local government may not require a utility to provide underground service for its own citizens as an operating expense.

Possibly as a response to this litigation, Dominion currently includes in its tariff a provision stating that “[w]hen any governmental authority requires . . . that electric lines and related facilities be located or relocated underground . . . the cost incurred by the Company . . . will be charged, in a manner approved by the Commission, to the Customers receiving electric service within the jurisdiction imposing the requirement.” Dominion has never had occasion to apply this provision, and no similar language appears in the other Utilities’ line extension plans.

Although the RVCC was unsuccessful in its effort to require the construction of underground facilities at Vepco’s expense, Dare County has continued to take an interest in burying electric lines. In 1999 the county secured the enactment of a local act (N.C. Session Law 1999-127) authorizing the creation of “one or more Utility Districts for the purpose of raising and expending funds to underground electric utility lines in the district.” The county commissioners may define the boundaries of a utility district to include any area outside a municipality, and any municipality may join the district. The county commissioners may levy a tax of up to \$1 per month on each bill for residential electric service within the utility district, and up to \$5 per month on each bill for commercial service. The tax will be collected by the electric suppliers, which will retain a percentage as compensation for their collection services. The proceeds of the tax will be used for the purpose of undergrounding electric lines within the district. The

---

<sup>14</sup> *State ex rel. Utilities Commission v. Roanoke Voyages Corridor Commission*, 76 N.C. App. 324, 332 S.E.2d 753 (1985).

1999 act applies only to Dare County, but other counties or municipalities may seek to have similar statutes enacted in the future. The main difficulty with the act appears to be that even if the \$1 and \$5 per month taxes are collected for a number of years, they may not prove sufficient to place underground more than a small portion of the electric lines in the district.

In some circumstances it may be in a utility's interest to convert overhead facilities to underground at its own expense in the interest of reliability. Dominion Virginia Power has adopted a policy of annually identifying the "worst 10 circuits" and "worst 10 devices" in each of its three Virginia regions, based on the total number of customer-hours out for each circuit and the total number of outages for each device. Appropriate steps are taken to improve or replace each of these circuits and devices. In some situations, the appropriate method of improving a low-ranking circuit or device may be to convert it to underground.

## **VII. Conclusions**

Based on the results of its investigation, the Public Staff concludes that it is not feasible to replace the existing overhead distribution power lines constructed by Duke, Progress Energy, and Dominion with underground power lines at this time. Such an undertaking would cost approximately \$41 billion and require 237 million man-hours to complete. This represents nearly a six-fold increase in current distribution assets of \$7.36 billion. It would take a construction work force of nearly 5,000 employees 25 years to complete the project and, in the end, result in an \$8.8 billion annual revenue requirement or an increase in rates of 10 cents per kWh, assuming the costs are spread uniformly to all customers.

The estimated conversion costs should be considered a minimum or a starting point, as they do not include other costs that are not quantified in this report but nevertheless would exist. In addition, there are higher costs to operate and maintain an underground system, which ultimately would be borne by the customer. While the O&M costs on a per mile basis for overhead systems and direct-buried underground systems are comparable, the O&M costs of underground systems with duct banks are almost four times more than that of overhead systems. Duct bank construction is needed in large cities to handle commercial loads where conductors are placed in concrete duct banks and transformers are located in underground vaults.

The reliability of underground systems during normal weather conditions is better than overhead systems. Underground systems experience about half as many system interruptions and tap line interruptions as overhead systems. This gain in reliability, however, is offset by a 58% increase in repair time, as underground faults require specialized repair crews to locate the faults, dig up the area around the fault, and repair the cable. In most cases, such an effort requires different crews and scheduling. During severe weather events, customers with underground facilities are less likely to be interrupted but will be among the last to have power restored when there is an underground fault.

The Public Staff believes the wisest course of action in view of these results is for the Utilities to continue their current practices of (1) adding new facilities underground when it is economical to do so or when the cost difference is paid by the customer or developer requesting the new underground service, (2) replacing existing overhead facilities with underground on a case-by-case basis upon request when the requesting

party pays the conversion costs, and (3) replacing overhead facilities with underground facilities in urban areas where factors such as load location and physical congestion make service impractical from overhead feeders.

The Public Staff also believes, however, that each of the Utilities should (1) identify the overhead facilities in each region it serves that repeatedly experience reliability problems based on measures such as number of outages or number of customer-hours out of service, (2) determine whether conversion to underground is a cost-effective option for improving the reliability of those facilities, and, if so, (3) develop a plan for converting those facilities to underground in an orderly and efficient manner, taking into account the outage histories and the impact on service reliability. Such a plan might include a policy similar to that of Dominion Virginia Power of annually identifying the “worst 10 circuits” and “worst 10 devices” in each of its regions and taking appropriate steps to improve or replace each of these circuits and devices.

**Underground Conversion Cost Estimates  
March 2003**

Instructions

For each line segment provide:

- 1) Estimated cost to convert existing circuit (Table I)
- 2) Note additional assumptions or conditions utilized for estimate
- 3) Provide estimated personnel-hours to complete the project (i.e., persons assigned to project multiplied by hours to complete) (Table II)

For "Greenfield" estimates, provide estimate to serve a new project:

- 1) UG residential subdivision
- 2) UG Commercial Shopping Center

**Table I - Conversion Costs**

Type of Facility	Urban	Suburban	Rural
Heavy Commercial District/Boulevard	(1)	Not Applicable	Not Applicable
Three Phase Bulk Feeder	Included Above	(2)	(2)
Three Phase Primary Tap (3)	Included Above	(3)	(3)
Single Phase Primary Tap (3)	Not Applicable	(3)	(3)
Services (cost per service) (4)	Not Applicable	(5)	(6)

**Assumptions**

- Rural scale 1=190'; Suburban scale 1"=200'
- All estimates based on construction methods designated by utility, including directional boring, trenching, landscaping
- Estimates to include material cost and associated labor to convert from existing OH to UG
- Costs include installation of UG facilities, plus removal and rearrangement of overhead facilities
- Street light circuit cost are excluded (unless noted otherwise on estimate)
- The primary voltage will be the predominant voltage used by the utility
- Provide a list of assumptions, materials and work methods for each estimate
- Cost to be converted to a per mile cost, based on length of existing OH primary circuit
- Specify type and size of facilities used
- Cost to include conversion of existing overhead transformers and services (commercial and residential)
- Include cost for switchgear to connect single and three phase tap (branch) lines
- Exclude cost of converting tap lines (end circuit in switchgear)
- Design UG circuits with back-feed capability
- See notes below for further instructions:
  - (1) Based on converting three phase overhead facilities along city blocks to UG:
    - Estimated based on a recent project (2001 or later) completed by the utility
    - Prefer projects in larger cities (i.e., Charlotte, Richmond, Raleigh, etc.)
  - (2) Based on converting three phase OH feeder circuit to UG (per drawing sample provided)
    - UG circuit with duct bank for suburban design (assume feeder tie to UG circuit)
    - Suburban feeder Hwy 70 to Mechanical to Hwy 401 – end of map
    - OH circuit for on rural feeder is radial feed – provide loop feed back to origin
    - Rural bulk feeder utilize Hwy 50
  - (3) Based on converting existing OH single and three phase branch circuits to UG
    - Utilize 1/0 UG circuits with closed loop
    - Suburban single phase circuit on Vester, Winterlochen and Jessup (assume 15 driveways each residential lot)
    - Suburban three phase circuit on Mechanical to McCormack and Hwy 70 @ Pep Boys to Drexmere. Close loop along Drexmere and McCormack Roads (assume 20' paved driveways on each commercial lot and 15' on residential)
    - Rural three phase tap utilize Hwy 50 (same as bulk feeder)
    - Rural single phase tap, utilize entire circuit feeding south to Parkers Mill Road (looped circuit)
  - (4) Single Phase Residential Services
  - (5) 150 foot service
  - (6) 250 foot service



In the table below provide **per mile** estimates for **conversion** personnel-hours:

**Table II - Conversion Man-hours**

Type of Facility	Urban	Suburban	Rural
<b>Heavy Commercial District/Boulevard</b>	(1)	Not Applicable	Not Applicable
<b>Three Phase Bulk Feeder</b>	Included Above	(2)	(2)
<b>Three Phase Primary Tap (3)</b>	Included Above	(3)	(3)
<b>Single Phase Primary Tap (3)</b>	Not Applicable	(3)	(3)
<b>Services (cost per service) (4)</b>	Not Applicable	(5)	(6)

**Assumptions**

- See Table I for construction description
- Estimates based on personnel-hours required to construct new circuit and remove existing facilities
- Personnel-hours equals hours on project times number of personnel to construct

In the table below provide **per mile** estimates for "**Greenfield**" costs:

**Table III – Greenfield Costs**

Type of Facility	Construction Cost
<b>Commercial Shopping Center</b>	
<b>Residential Subdivision Scale 1"=100'</b>	

**Assumptions**

- Provide estimates to construct UG facilities to serve sample projects
- Utilize your company's existing construction and design standards
- Provide list of assumptions, materials and work methods
- Assume 2200 – 2400 square foot all-electric homes
- 4 ton heat pump, with 2-7.5 kW strip heat
- Utilize Summers Place subdivision Phase 2 lot layout